

110MHz Current Feedback Amplifier with Disable



The EL2166 is a current feedback operational amplifier with -3dB bandwidth of 110MHz at a gain of +2.

Built using the Elantec proprietary monolithic complementary bipolar process, this amplifier uses current mode feedback to achieve more bandwidth at a given gain than a conventional voltage feedback operational amplifier.

The EL2166 is designed to drive a double terminated 75Ω coax cable to video levels. Differential gain and phase are excellent when driving both loads of 500Ω (< 0.01%/< 0.01°) and double terminated 75Ω cables (0.025%/0.05° @ $V_S = \pm 15V$, 0.04%/0.02° @ $V_S = \pm 5V$).

The EL2166 has a superior output disable function. Time to enable or disable is < 75ns. The $\overline{\text{DISABLE}}$ pin is TTL/CMOS compatible. In disable mode, the amplifier can withstand over 1500V/μs signals at their outputs. The amplifier can operate on any supply voltage from 10V (±5V) to 33V (±16.5V), yet consume only 7.5mA at any supply voltage. The EL2166 is available in 8-pin PDIP and 8-pin SO packages.

Pinout

**EL2166
(8-PIN SO, PDIP)
TOP VIEW**

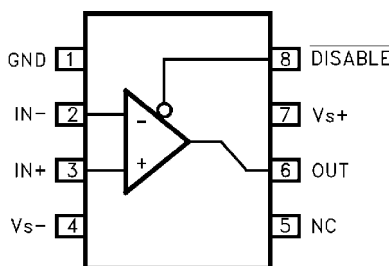

Manufactured under U.S. Patent No. 5,420,542, 4,893,091

Features

- 110MHz 3dB bandwidth ($A_V = +2$)
- 115MHz 3dB bandwidth ($A_V = +1$)
- 0.01% differential gain, $R_L = 500\Omega$
- 0.01° differential phase, $R_L = 500\Omega$
- Low supply current, 7.5mA
- Fast disable < 75ns
- Low cost
- 1500 V/μs slew rate

Applications

- Video amplifiers
- Cable drivers
- RGB amplifiers
- Test equipment amplifiers
- Current to voltage converters
- Broadcast equipment
- High speed communications
- Video multiplexing

Ordering Information

| PART NUMBER | TEMP. RANGE | PACKAGE | PKG. NO. |
|-------------|----------------|------------|----------|
| EL2166CN | -40°C to +85°C | 8-Pin PDIP | MDP0031 |
| EL2166CS | -40°C to +85°C | 8-Pin SOIC | MDP0027 |

Absolute Maximum Ratings ($T_A = 25^\circ\text{C}$)

Voltage between V_{S+} and V_{S-} +33V
 Voltage between +IN and -IN $\pm 6\text{V}$
 Current into +IN or -IN 10mA
 Output Current $\pm 50\text{mA}$
 Current into $\overline{\text{DISABLE}}$ Pin $\pm 5\text{mA}$
 Voltage between $\overline{\text{DISABLE}}$ Pin and GND Pin $\pm 7\text{V}$

Voltage at IN+, IN-, V_{OUT} ,
 $\overline{\text{DISABLE}}$, GND Pins (V_{S-}) - 0.5V to (V_{S+}) +0.5V
 Internal Power Dissipation See Curves
 Operating Ambient Temperature Range -40°C to $+85^\circ\text{C}$
 Operating Junction Temperature Plastic Packages 150°C
 Storage Temperature Range -65°C to $+150^\circ\text{C}$

CAUTION: Stresses above those listed in "Absolute Maximum Ratings" may cause permanent damage to the device. This is a stress only rating and operation of the device at these or any other conditions above those indicated in the operational sections of this specification is not implied.

IMPORTANT NOTE: All parameters having Min/Max specifications are guaranteed. Typical values are for information purposes only. Unless otherwise noted, all tests are at the specified temperature and are pulsed tests, therefore: $T_J = T_C = T_A$

Open-Loop DC Electrical Specifications

$V_S = \pm 15\text{V}$, $R_L = 150\Omega$, $T_A = 25^\circ\text{C}$ unless otherwise specified

| PARAMETER | DESCRIPTION | CONDITIONS | TEMP | LIMITS | | | UNITS |
|-----------------------|---|---|--------------------|------------|------------|------|------------------------------|
| | | | | MIN | TYP | MAX | |
| V_{OS} | Input Offset Voltage | $V_S = \pm 5\text{V}, \pm 15\text{V}$ | 25°C | | 2 | 10 | mV |
| TC V_{OS} | Average Offset Voltage Drift (Note 1) | | Full | | 10 | | $\mu\text{V}/^\circ\text{C}$ |
| + I_{IN} | +Input Current | $V_S = \pm 5\text{V}, \pm 15\text{V}$ | 25°C | | 0.5 | 5 | μA |
| - I_{IN} | -Input Current | $V_S = \pm 5\text{V}, \pm 15\text{V}$ | 25°C | | 5 | 20 | μA |
| CMRR | Common Mode Rejection Ratio (Note 2) | $V_S = \pm 5\text{V}, \pm 15\text{V}$ | 25°C | 55 | 62 | | dB |
| -ICMR | -Input Current Common Mode Rejection (Note 2) | $V_S = \pm 5\text{V}, \pm 15\text{V}$ | 25°C | | 0.1 | 2 | $\mu\text{A}/\text{V}$ |
| PSRR | Power Supply Rejection Ratio (Note 3) | | 25°C | 65 | 72 | | dB |
| -IPSR | -Input Current Power Supply Rejection (Note 3) | | 25°C | | 0.1 | 2 | $\mu\text{A}/\text{V}$ |
| R_{OL} | Transimpedance (Note 4) | $V_S = \pm 15\text{V}$ | 25°C | 500 | 2000 | | $\text{k}\Omega$ |
| | | $R_L = 400\Omega$ | | | | | |
| | | $V_S = \pm 5\text{V}$ | 25°C | 500 | 1200 | | $\text{k}\Omega$ |
| | | $R_L = 150\Omega$ | | | | | |
| + R_{IN} | +Input Resistance | | 25°C | 2.0 | 5.0 | | $\text{M}\Omega$ |
| + C_{IN} | +Input Capacitance | | 25°C | | 2.5 | | pF |
| CMIR | Common Mode Input Range | $V_S = \pm 15\text{V}$ | 25°C | ± 12.6 | ± 13.2 | | V |
| | | $V_S = \pm 5\text{V}$ | 25°C | ± 2.6 | ± 3.2 | | V |
| V_{O} | Output Voltage Swing | $R_L = 400\Omega, V_S = \pm 15\text{V}$ | 25°C | ± 12 | ± 13.5 | | V |
| | | $R_L = 150\Omega, V_S = \pm 15\text{V}$ | 25°C | | ± 11.4 | | V |
| | | $R_L = 150\Omega, V_S = \pm 5\text{V}$ | 25°C | ± 3.0 | ± 3.7 | | V |
| I_{SC} | Output Short Circuit Current (Note 5) | $V_S = \pm 5\text{V}, V_S = \pm 15\text{V}$ | 25°C | 50 | 80 | 130 | mA |
| I_{S} | Supply Current | $V_S = \pm 15\text{V}, V_S = \pm 5\text{V}$ | 25°C | | 7.5 | 10.0 | mA |
| $I_{\text{S, OFF}}$ | Supply Current Disabled, Pin 8 = 0V | | 25°C | | 7.3 | 10.0 | mA |
| $I_{\text{OUT, OFF}}$ | Output Current Disabled, Pin 8 = 0V | $A_V = +1$ | 25°C | | 2.0 | 50.0 | μA |
| V_{IH} | $\overline{\text{DISABLE}}$ Pin Voltage for Output Enabled (Note 6) | | 25°C | 2.0 | | | V |
| V_{IL} | $\overline{\text{DISABLE}}$ Pin Threshold for Output Disabled | | 25°C | | | 0.8 | V |

Open-Loop DC Electrical Specifications

$V_S = \pm 15V$, $R_L = 150\Omega$, $T_A = 25^\circ C$ unless otherwise specified (Continued)

| PARAMETER | DESCRIPTION | CONDITIONS | TEMP | LIMITS | | | UNITS |
|-----------------------|--|------------|------|--------|-----|-----|-------|
| | | | | MIN | TYP | MAX | |
| I _{DIS, ON} | $\overline{\text{DISABLE}}$ Pin Input Current, Pin 8 = +5V | | 25°C | | 70 | 150 | μA |
| I _{DIS, OFF} | $\overline{\text{DISABLE}}$ Pin Input Current, Pin 8 = 0V | | 25°C | -150 | -60 | | μA |

NOTES:

1. Measured from T_{MIN} to T_{MAX}.
2. V_{CM} = ±12.6V for V_S = ±15V and T_A = 25°C. V_{CM} = ±2.6V for V_S = ±5V and T_A = 25°C.
3. The supplies are moved from ±5V to ±15V.
4. V_{OUT} = ±7V for V_S = ±15V, and V_{OUT} = ±2V for V_S = ±5V.
5. A heat sink is required to keep junction temperature below absolute maximum when an output is shorted.
6. The EL2166 will remain ENABLED if pin 8 is either left unconnected or VIH is applied to pin 8.

Closed-Loop AC Electrical Specifications

$V_S = \pm 15V$, $A_V = +2$, $R_F = 560\Omega$, $R_L = 150\Omega$, $T_A = 25^\circ C$ unless otherwise noted

| PARAMETER | DESCRIPTION | CONDITIONS | LIMITS | | | UNITS |
|---------------------------------|-------------------------------------|-------------------------------------|--------|-------|-----|---------|
| | | | MIN | TYP | MAX | |
| BW | -3dB Bandwidth (Note 1) | $V_S = \pm 15V$, $A_V = +2$ | | 110 | | MHz |
| | | $V_S = \pm 15V$, $A_V = +1$ | | 115 | | MHz |
| | | $V_S = \pm 5V$, $A_V = +2$ | | 95 | | MHz |
| | | $V_S = \pm 5V$, $A_V = +1$ | | 100 | | MHz |
| SR | Slew Rate (Note 1)(Note 2) | $R_L = 400\Omega$ | 1000 | 1500 | | V/μs |
| t _R , t _F | Rise Time, Fall Time (Note 1) | V _{OUT} = ±500mV | | 3.2 | | ns |
| t _{PD} | Propagation Delay (Note 1) | | | 4.3 | | ns |
| OS | Overshoot (Note 1) | V _{OUT} = ±500mV | | 7 | | % |
| t _S | 0.1% Settling Time (Note 1) | V _{OUT} = ±10V | | 35 | | ns |
| | | $A_V = \pm 1$, $R_L = 1k$ | | | | |
| dG | Differential Gain (Note 1)(Note 3) | $R_L = 150\Omega$, $V_S = \pm 15V$ | | 0.025 | | % |
| | | $R_L = 150\Omega$, $V_S = \pm 5V$ | | 0.05 | | % |
| | | $R_L = 500\Omega$, $V_S = \pm 15V$ | | 0.01 | | % |
| | | $R_L = 500\Omega$, $V_S = 5V$ | | 0.01 | | % |
| dP | Differential Phase (Note 1)(Note 3) | $R_L = 150\Omega$, $V_S = \pm 15V$ | | 0.04 | | deg (°) |
| | | $R_L = 150\Omega$, $V_S = \pm 5V$ | | 0.02 | | deg (°) |
| | | $R_L = 500\Omega$, $V_S = \pm 15V$ | | 0.01 | | deg (°) |
| | | $R_L = 500\Omega$, $V_S = 5V$ | | 0.01 | | deg (°) |
| t _{DIS} | Disable/Enable Time (Note 4) | | | 75 | | ns |

NOTES:

1. All AC tests are performed on a “warmed up” part, except for Slew Rate, which is pulse tested.
2. Slew Rate is with V_{OUT} from +10V to -10V and measured at the 25% and 75% points.
3. DC offset from -0.714V through +0.714V, AC amplitude 286 mV_{p-p}, f = 3.58MHz.
4. Disable/Enable time is defined as the time from when the logic signal is applied to the $\overline{\text{DISABLE}}$ pin to when the output voltage has gone 50% of the way from its initial to its final value.

Typical Performance Curves

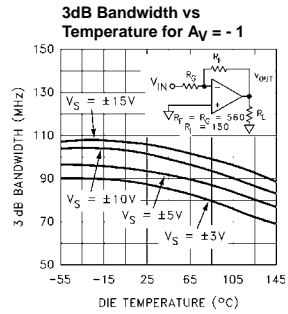
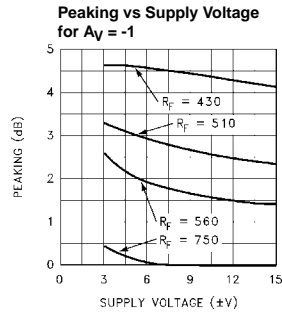
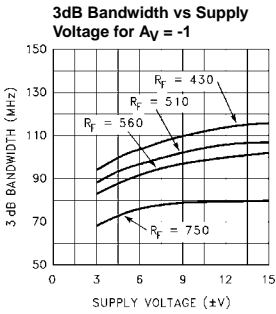
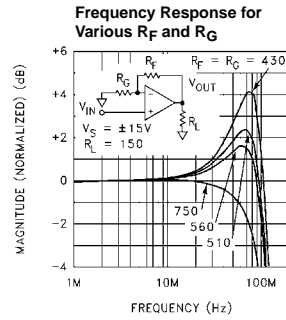
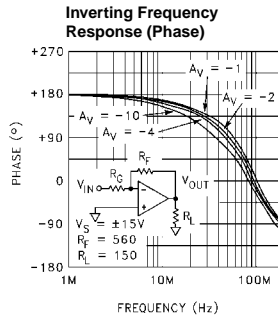
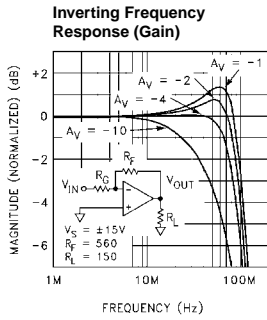
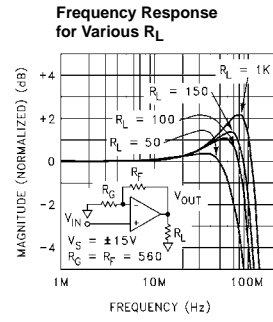
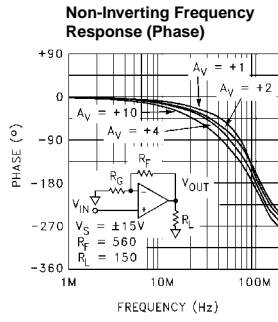
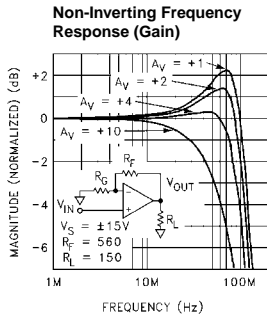

Typical Performance Curves (Continued)

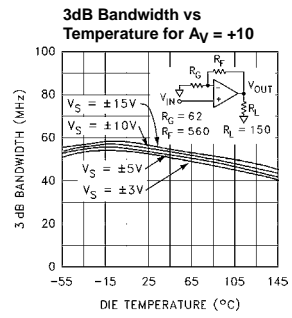
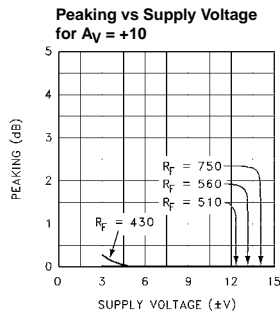
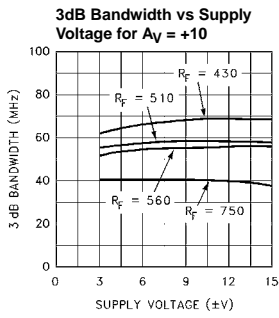
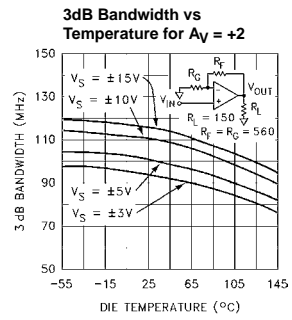
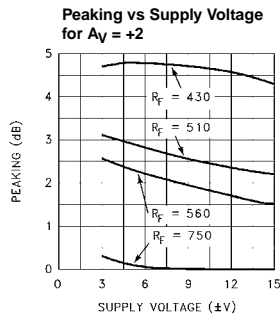
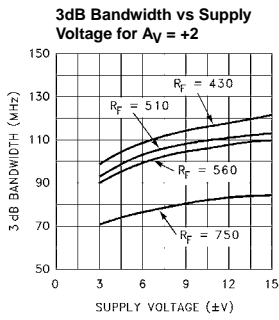
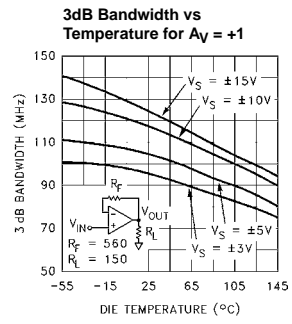
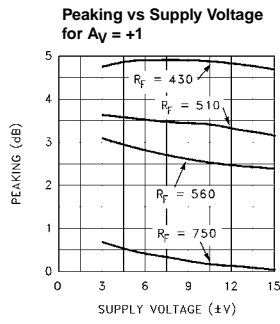
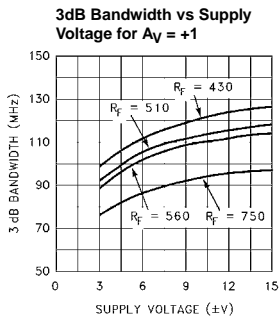

Typical Performance Curves (Continued)

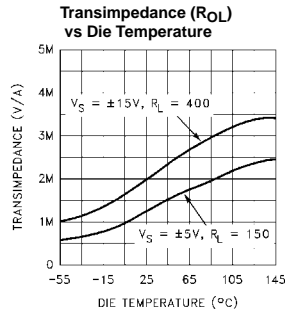
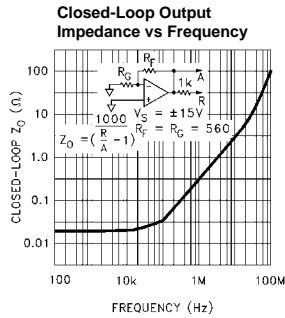
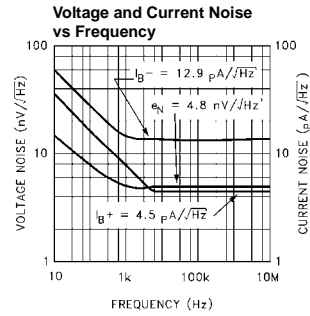
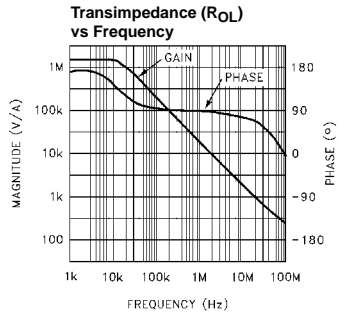
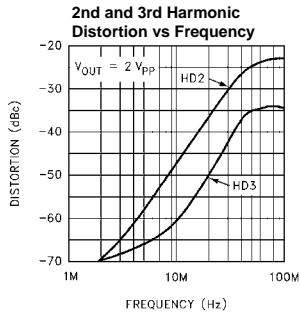
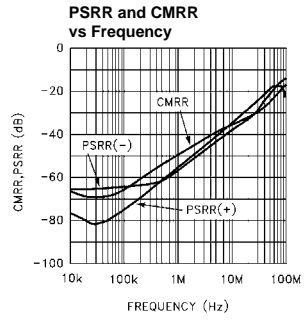
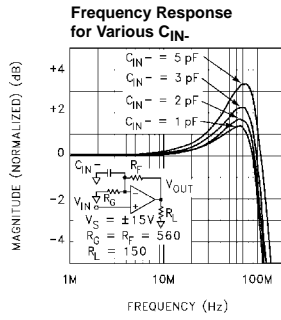
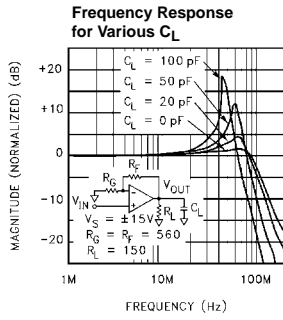

Typical Performance Curves (Continued)

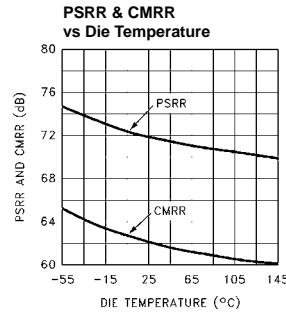
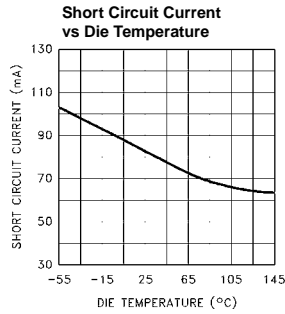
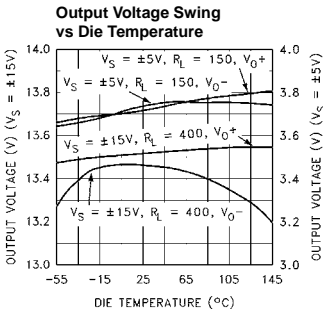
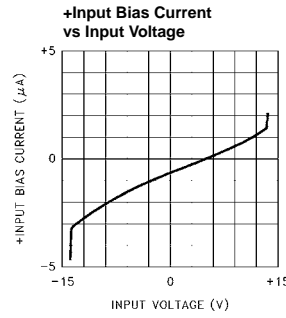
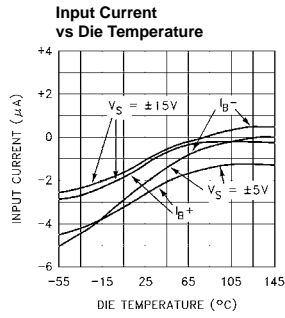
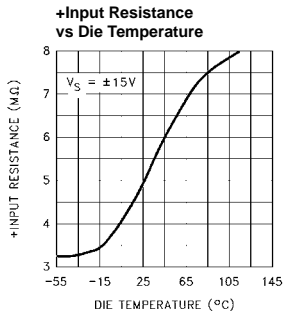
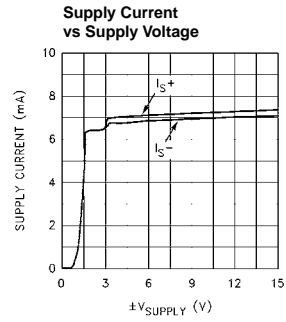
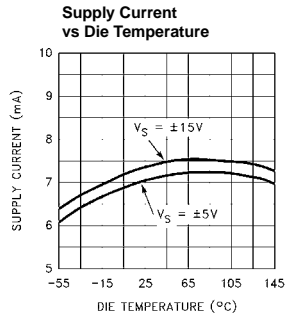
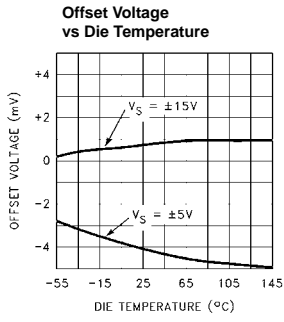

Typical Performance Curves (Continued)

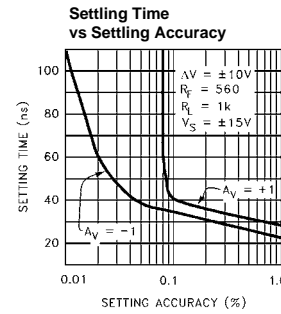
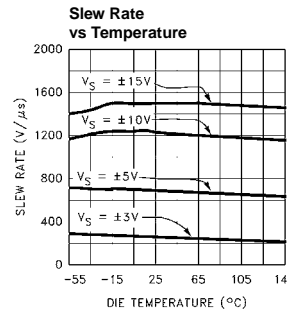
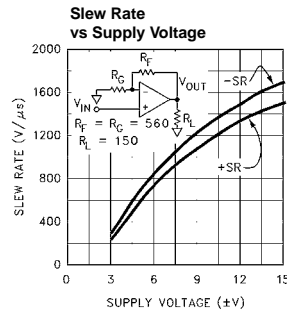
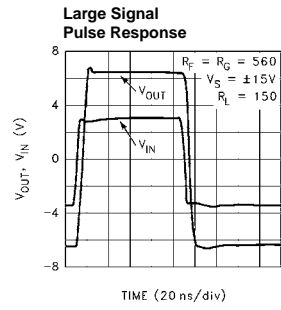
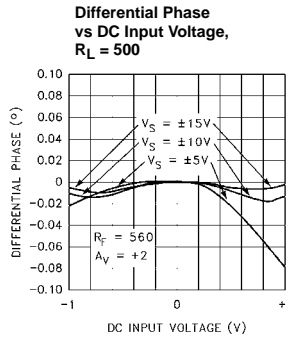
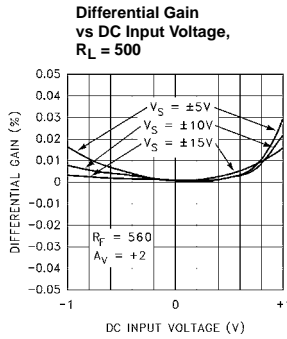
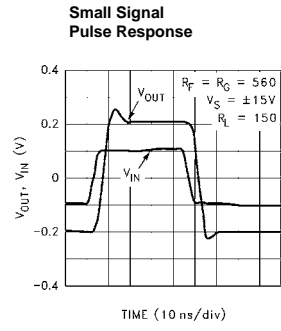
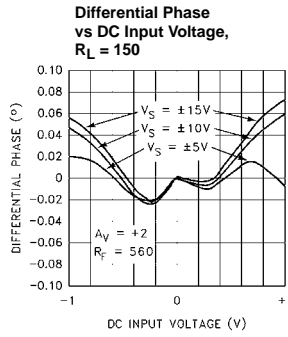
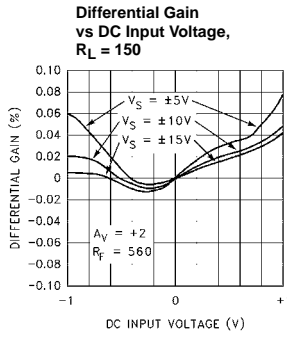

Typical Performance Curves (Continued)

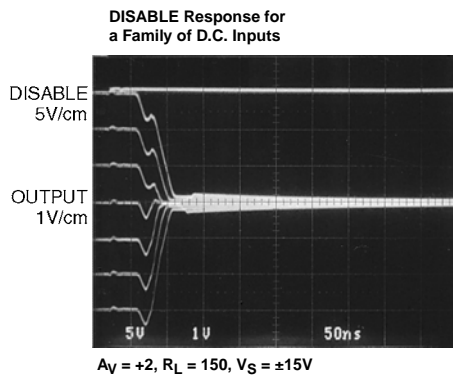
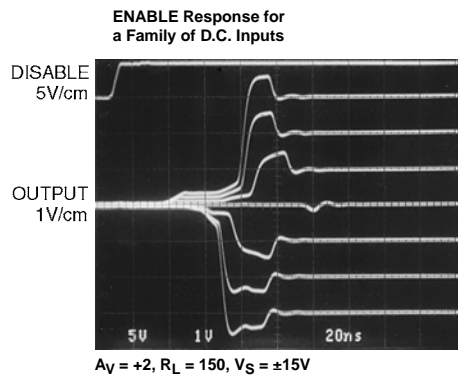
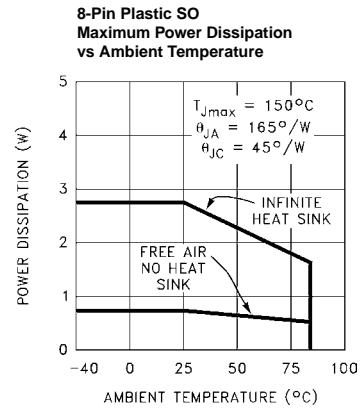
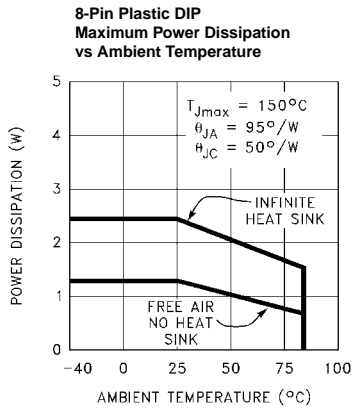
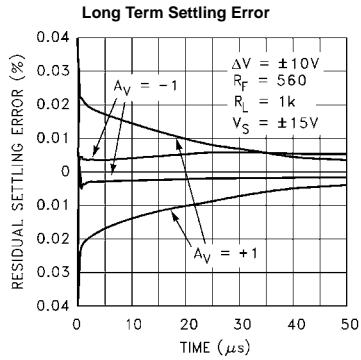

Burn-In Circuit

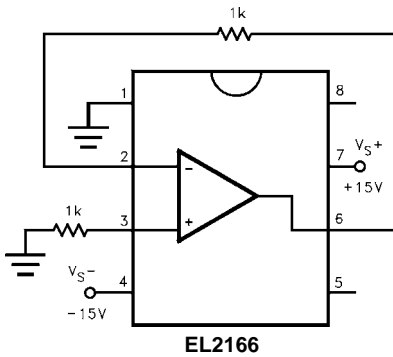

Differential Gain and Phase Test Circuit

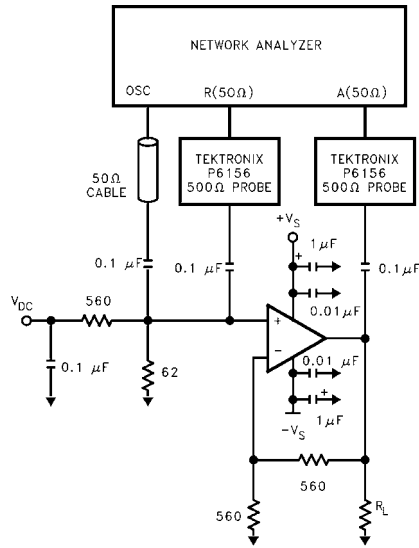

Simplified Schematic

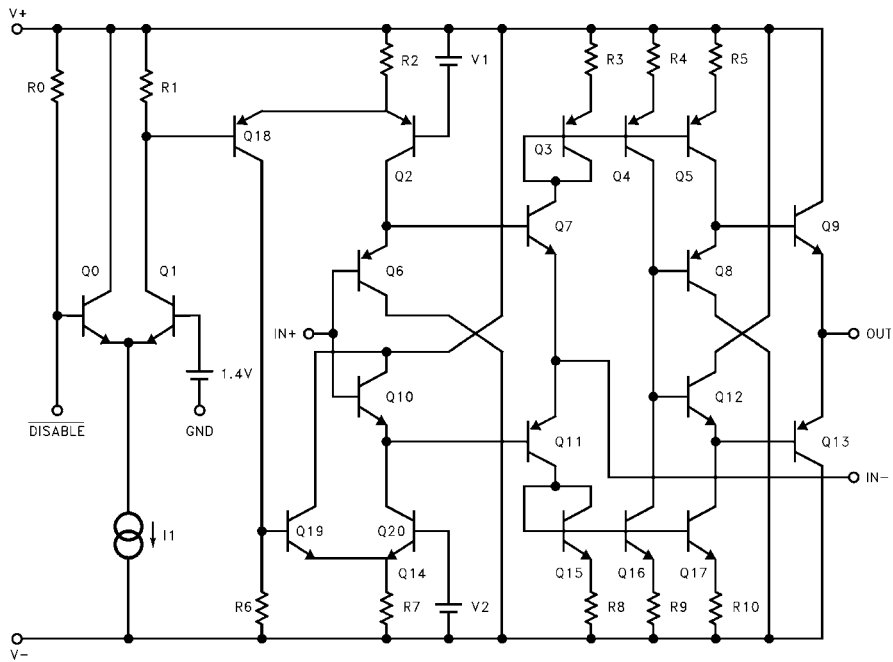

Applications Information

Product Description

The EL2166 is a current mode feedback amplifier that offers wide bandwidth and good video specifications at a moderately low supply current. It is built using Elantec's proprietary complimentary bipolar process and is offered in industry standard pin-outs. Due to the current feedback architecture, the EL2166 closed-loop 3dB bandwidth is dependent on the value of the feedback resistor. First the desired bandwidth is selected by choosing the feedback resistor, R_F and then the gain is set by picking the gain resistor, R_G . The curves at the beginning of the Typical Performance Curves section show the effect of varying both R_F and R_G . The 3dB bandwidth is only slightly dependent on the power supply voltage. The bandwidth reduces from 110MHz to 95MHz as supplies are varied from $\pm 15V$ to $\pm 5V$. To compensate for this, smaller values of feedback resistor can be used at lower supply voltages.

Power Supply Bypassing and Printed Circuit Board Layout

As with any high frequency device, good printed circuit board layout is necessary for optimum performance. Ground plane construction is highly recommended. Lead lengths should be as short as possible, below 1/4". The power supply pins must be well bypassed to reduce the risk of oscillation. A 1.0 μ F tantalum capacitor in parallel with a 0.01 μ F ceramic capacitor is adequate for each supply pin.

For good AC performance, parasitic capacitances should be kept to a minimum, especially at the inverting input (see Capacitance at the Inverting Input section). This implies keeping the ground plane away from this pin. Carbon resistors are acceptable, while use of wire-wound resistors should not be used because of their parasitic inductance. Similarly, capacitors should be low inductance for best performance. Use of sockets, particularly for the SO package, should be avoided. Sockets add parasitic inductance and capacitance which will result in peaking and overshoot.

Capacitance at the Inverting Input

Due to the topology of the current feedback amplifier, stray capacitance at the inverting input will affect the AC and transient performance of the EL2166 when operating in the non-inverting configuration. The characteristic curve of gain vs. frequency with variations of C_{IN-} emphasizes this effect. The curve illustrates how the bandwidth can be extended over 30MHz with some additional peaking with an additional 5pF of capacitance at the V_{IN-} pin for the case of $A_V = +2$. Higher values of capacitance will be required to obtain similar effects at higher gains.

In the inverting gain mode, added capacitance at the inverting input has little effect since this point is at a virtual

ground and stray capacitance is therefore not "seen" by the amplifier.

Feedback Resistor Values

The EL2166 has been designed and specified with $R_F = 560\Omega$ for $A_V = +2$. This value of feedback resistor yields relatively flat frequency response with < 1.5dB peaking out to 110MHz. As is the case with all current feedback amplifiers, wider bandwidth, at the expense of slight peaking, can be obtained by reducing the value of the feedback resistor. Inversely, larger values of feedback resistor will cause rolloff to occur at a lower frequency. By reducing R_F to 430 Ω , bandwidth can be extended to 120MHz with 4.5dB of peaking. See the curves in the Typical Performance Curves section which show 3dB bandwidth and peaking vs. frequency for various feedback resistors and various supply voltages.

Bandwidth vs Temperature

Whereas many amplifier's supply current and consequently 3dB bandwidth drop off at high temperature, the EL2166 was designed to have little supply current variations with temperature. An immediate benefit from this is that the 3dB bandwidth does not drop off drastically with temperature. With $V_S = \pm 15V$ and $A_V = +2$, the bandwidth only varies from 115MHz to 95MHz over the entire die junction temperature range of $0^\circ C < T < 150^\circ C$.

Supply Voltage Range

The EL2166 has been designed to operate with supply voltages from $\pm 5V$ to $\pm 15V$. AC performance, including -3dB bandwidth and differential gain and phase, shows little degradation as the supplies are lowered to $\pm 5V$. For example, as supplies are lowered from $\pm 15V$ to $\pm 5V$, -3dB bandwidth reduces only 15MHz, and differential gain and phase remain less than 0.05%/0.02° respectively.

If a single supply is desired, values from +10V to +30V can be used as long as the input common mode range is not exceeded. When using a single supply, be sure to either 1) DC bias the inputs at an appropriate common mode voltage and AC couple the signal, or 2) ensure the driving signal is within the common mode range of the EL2166.

Disable Function

The EL2166 has a superior disable function that has been optimized for video performance. Time to disable/enable is around 75ns.

During disable, the output of the EL2166 can withstand over 1500V/ μ s slew rate signals at its output and the output does not draw excessive currents. The feed-through can be modeled as a 1.5pF capacitor from V_{IN+} to the output, and the output impedance can be modeled as 4.4pF in parallel with 180k Ω to ground when disabled. Consequently, multiplexing with the EL2166 is very easy. Simply tie the outputs of multiple EL2166s together and drive the /DISABLE pins with standard TTL or CMOS signals. The

disable signal applied to the /DISABLE pin is referenced to the GND pin. The GND pin can be tied as low as the V_{S-} pin. This allows the EL2166 to be operated on a single supply. For example, one could tie the V_{S-} and GND pins to 0V and V_{S+} to +10V, and then use standard TTL or CMOS to drive the /DISABLE pin. Remember to keep the inputs of the EL2166 within their common mode range.

Multiplexing with the EL2166

An example of multiplexing with the EL2166 and its response curve is shown below. Always be sure that no more than $\pm 5V$ is applied between V_{IN+} and V_{IN-} , which is compatible with standard video signals. This usually becomes an issue only when using the disable feature and amplifying large voltages.

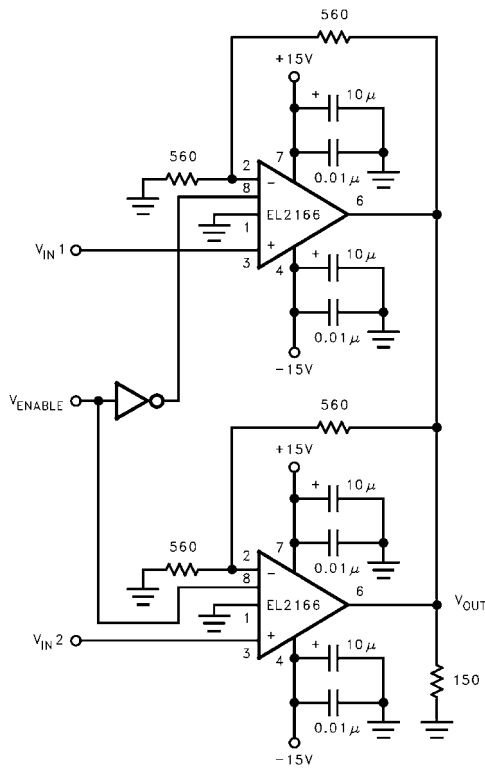

DUAL EL2166 MULTIPLEXER

In the multiplexer above, suppose one amp is disabled and the other has amplified a signal to +10V at V_{OUT} . The voltage at pin 2 of the disabled amplifier will now be +5V due to the resistor divider action. Therefore, any applied voltage at pin 3 of the disabled amplifier must remain above 0V if the voltage between pins 2 and 3 of the disabled amplifier is to remain less than 5V. Also keep in mind that each disabled amplifier adds more capacitance to the bus, as discussed above. See Disable Function, and Driving Cables and Capacitive Loads in this section, and the Frequency

Response for Various C_L curves in the Typical Performance Curve section.

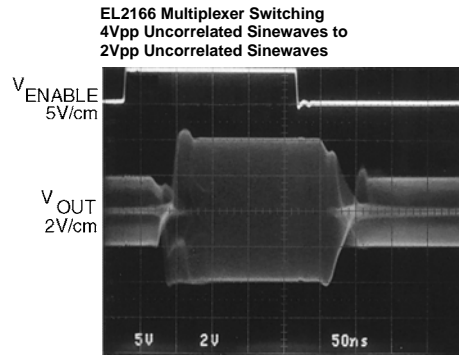

Settling Characteristics

The EL2166 offers superb settling characteristics to 0.1%, typically in the 35ns to 40ns range. There are no aberrations created from the input stage which often cause longer settling times in other current feedback amplifiers. The EL2166 is not slew rate limited, therefore any size step up to $\pm 10V$ gives approximately the same settling time.

As can be seen from the Long Term Settling Error curve, for $A_V = +1$, there is approximately a 0.02% residual which tails away to 0.01% in about 20 μs . This is a thermal settling error caused by a power dissipation differential (before and after the voltage step). For $A_V = -1$, due to the inverting mode configuration, this tail does not appear since the input stage does not experience the large voltage change as in the non-inverting mode. With $A_V = -1$, 0.01% settling time is slightly greater than 100ns.

Power Dissipation

The EL2166 amplifier combines both high speed and large output current drive capability at a moderate supply current in very small packages. It is possible to exceed the maximum junction temperature allowed under certain supply voltage, temperature, and loading conditions. To ensure that the EL2166 remains within its absolute maximum ratings, the following discussion will help to avoid exceeding the maximum junction temperature.

The maximum power dissipation allowed in a package is determined by its thermal resistance and the amount of temperature rise according to:

$$P_{DMAX} = \frac{T_{JMAX} - T_{AMAX}}{\theta_{JA}}$$

The maximum power dissipation actually produced by an IC is the total quiescent supply current times the total power supply voltage plus the power in the IC due to the load, or

$$P_{DMAX} = 2 \times V_S + (V_S - V_{OUT}) \times \frac{V_{OUT}}{R_L}$$

where I_S is the supply current. (To be more accurate, the quiescent supply current flowing in the output driver transistor should be subtracted from the first term because, under loading and due to the class AB nature of the output stage, the output driver current is now included in the second term.)

In general, an amplifier's AC performance degrades at higher operating temperature and lower supply current. Unlike some amplifiers, the EL2166 maintains almost constant supply current over temperature so that AC performance is not degraded as much over the entire operating temperature range. Of course, this increase in performance doesn't come for free. Since the current has increased, supply voltages must be limited so that maximum power ratings are not exceeded.

The EL2166 consumes typically 7.5mA and maximum 10.0mA. The worst case power in an IC occurs when the output voltage is at half supply, if it can go that far, or its maximum values if it cannot reach half supply. If we set the two P_{DMAX} equations equal to each other, and solve for V_S , we can get a family of curves for various loads and output voltages according to:

$$V_S = \frac{R_L \times (T_{JMAX} - T_{AMAX})}{\theta_{JA}} + (V_{OUT})^2}{(2 \times I_S \times R_L) + V_{OUT}}$$

The following curves show supply voltage ($\pm V_S$) vs R_{LOAD} for various output voltage swings for the 2 different

packages. The curves assume worst case conditions of $T_A = +85^\circ\text{C}$ and $I_S = 10\text{mA}$.

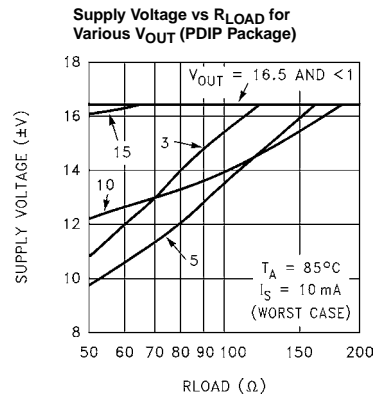
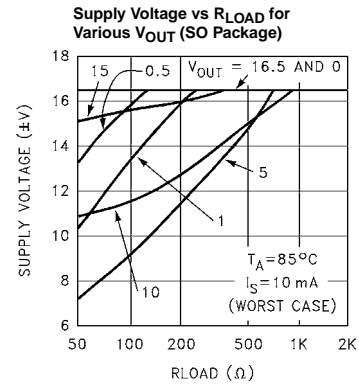

The curves do not include heat removal or forcing air, or the simple fact that the package will probably be attached to a circuit board, which can also provide some form of heat removal. Larger temperature and voltage ranges are possible with heat removal and forcing air past the part.

Current Limit

The EL2166 has an internal current limit that protects the circuit in the event of the output being shorted to ground. This limit is set at 80mA nominally and reduces with junction temperature. At a junction temperature of 150°C, the current limits at about 50mA. If the output is shorted to ground, the power dissipation could be well over 1W. Heat removal is required in order for the EL2166 to survive an indefinite short.

Driving Cables and Capacitive Loads

When used as a cable driver, double termination is always recommended for reflection-free performance. For those applications, the back termination series resistor will decouple the EL2166 from the capacitive cable and allow extensive capacitive drive. However, other applications may have high capacitive loads without termination resistors. In these applications, an additional small value (5Ω–50Ω) resistor in series with the output will eliminate most peaking. The gain resistor, R_G , can be chosen to make up for the gain loss created by this additional series resistor at the output.

EL2166 Macromodel

* Revision A, May 1994

* AC Characteristics used C_{IN^-} (pin 2) = 1pF; R_F = 560 Ω

```
* Connections:      +input
*                   |
*                   | -input
*                   | |
*                   | | +Vsupply
*                   | | |
*                   | | | -Vsupply
*                   | | | |
*                   | | | | output
*                   | | | | |
.subckt EL2166/EL 3 2 7 4 6
*
```

* Input Stage

```
*
e1 10 0 3 0 1.0
vis 10 9 0V
h2 9 12 vxx 1.0
r1 2 11 130
l1 11 12 25nH
iinp 3 0 0.5 $\mu$ A
iim 2 0 5 $\mu$ A
r12 3 0 2Meg
*
```

* Slew Rate Limiting

```
*
h1 13 0 vis 600
r2 13 14 1K
d1 14 0 dclamp
d2 0 14 dclamp
*
```

* High Frequency Pole

```
*
*e2 30 0 14 0 0.001666666666
l3 30 17 0.8 $\mu$ H
c5 17 0 1.25pF
r5 17 0 500
*
```

* Transimpedance Stage

```
*
g1 0 18 17 0 1.0
ro1 18 0 2Meg
cdp 18 0 2.9pF
*
```

* Output Stage

```
*
q1 4 18 19 qp
q2 7 18 20 qn
q3 7 19 21 qn
q4 4 20 22 qp
r7 21 6 4
r8 22 6 4
ios1 7 19 2mA
ios2 20 4 2mA
*
```

* Supply Current

```
*
ips 7 4 2mA
*
```

* Error Terms

```
*
ivos 0 23 2mA
```

```

vxx 23 0 0V
e4 24 0 3 0 1.35K
e5 25 0 7 0 1.0
e6 26 0 4 0 1.0
r9 24 23 562
r10 25 23 1K
r11 26 23 1K
*
* Models
*
.model qn npn (is=5e-15 bf=200 tf=0.1ns)
.model qp pnp (is=5e-15 bf=200 tf=0.1ns)
.model dclamp d (is=1e-30 ibv=0.266 bv=2.8 n=4)
.ends
    
```

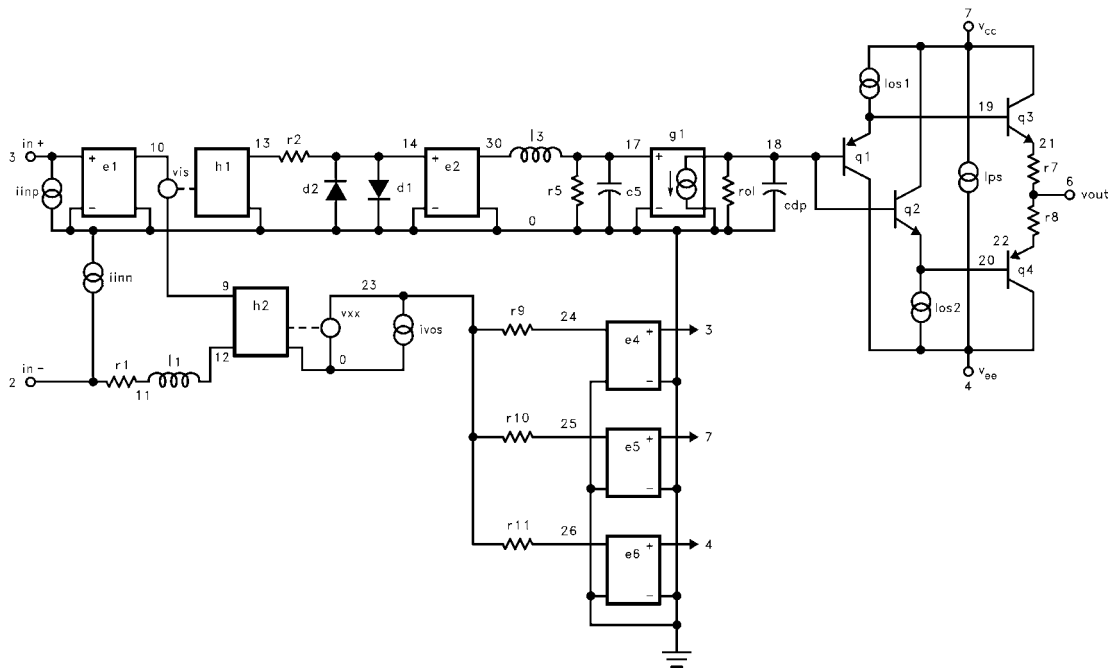

All Intersil U.S. products are manufactured, assembled and tested utilizing ISO9000 quality systems.
 Intersil Corporation's quality certifications can be viewed at www.intersil.com/design/quality

Intersil products are sold by description only. Intersil Corporation reserves the right to make changes in circuit design, software and/or specifications at any time without notice. Accordingly, the reader is cautioned to verify that data sheets are current before placing orders. Information furnished by Intersil is believed to be accurate and reliable. However, no responsibility is assumed by Intersil or its subsidiaries for its use; nor for any infringements of patents or other rights of third parties which may result from its use. No license is granted by implication or otherwise under any patent or patent rights of Intersil or its subsidiaries.

For information regarding Intersil Corporation and its products, see www.intersil.com