

- Rugged Triple-Diffused Planar Construction
- 10 A Continuous Collector Current
- Operating Characteristics Fully Guaranteed at 100°C
- 1000 Volt Blocking Capability
- 125 W at 25°C Case Temperature

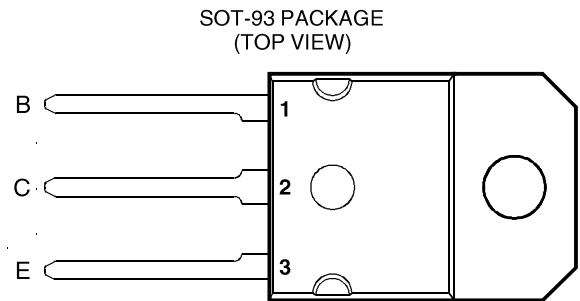

Pin 2 is in electrical contact with the mounting base.

absolute maximum ratings **at 25°C case temperature (unless otherwise noted)**

RATING		SYMBOL	VALUE	UNIT
Collector-base voltage ($I_E = 0$)	TIPL765	V_{CBO}	850	V
	TIPL765A		1000	
Collector-emitter voltage ($V_{BE} = 0$)	TIPL765	V_{CES}	850	V
	TIPL765A		1000	
Collector-emitter voltage ($I_B = 0$)	TIPL765	V_{CEO}	400	V
	TIPL765A		450	
Emitter-base voltage		V_{EBO}	10	V
Continuous collector current		I_C	10	A
Peak collector current (see Note 1)		I_{CM}	15	A
Continuous device dissipation at (or below) 25°C case temperature		P_{tot}	125	W
Operating junction temperature range		T_j	-65 to +150	°C
Storage temperature range		T_{stg}	-65 to +150	°C

NOTE 1: This value applies for $t_p \leq 10$ ms, duty cycle $\leq 2\%$.

TIPL765, TIPL765A

NPN SILICON POWER TRANSISTORS

electrical characteristics at 25°C case temperature (unless otherwise noted)

PARAMETER	TEST CONDITIONS			MIN	TYP	MAX	UNIT
$V_{CEO(sus)}$ Collector-emitter sustaining voltage	$I_C = 100 \text{ mA}$	$L = 25 \text{ mH}$	(see Note 2)	TIPL765 400 TIPL765A 450			V
I_{CES} Collector-emitter cut-off current	$V_{CE} = 850 \text{ V}$	$V_{BE} = 0$		TIPL765		50	μA
	$V_{CE} = 1000 \text{ V}$	$V_{BE} = 0$		TIPL765A		50	
	$V_{CE} = 850 \text{ V}$	$V_{BE} = 0$	$T_C = 100^\circ\text{C}$	TIPL765		200	
	$V_{CE} = 1000 \text{ V}$	$V_{BE} = 0$	$T_C = 100^\circ\text{C}$	TIPL765A		200	
I_{CEO} Collector cut-off current	$V_{CE} = 400 \text{ V}$	$I_B = 0$		TIPL765		50	μA
	$V_{CE} = 450 \text{ V}$	$I_B = 0$		TIPL765A		50	
I_{EBO} Emitter cut-off current	$V_{EB} = 10 \text{ V}$	$I_C = 0$				1	mA
h_{FE} Forward current transfer ratio	$V_{CE} = 5 \text{ V}$	$I_C = 0.5 \text{ A}$	(see Notes 3 and 4)	15		60	
$V_{CE(sat)}$ Collector-emitter saturation voltage	$I_B = 0.4 \text{ A}$	$I_C = 2 \text{ A}$				0.5	V
	$I_B = 1 \text{ A}$	$I_C = 5 \text{ A}$	(see Notes 3 and 4)			1.0	
	$I_B = 2 \text{ A}$	$I_C = 10 \text{ A}$				2.5	
	$I_B = 2 \text{ A}$	$I_C = 10 \text{ A}$	$T_C = 100^\circ\text{C}$			5.0	
$V_{BE(sat)}$ Base-emitter saturation voltage	$I_B = 0.4 \text{ A}$	$I_C = 2 \text{ A}$				1.1	V
	$I_B = 1 \text{ A}$	$I_C = 5 \text{ A}$	(see Notes 3 and 4)			1.3	
	$I_B = 2 \text{ A}$	$I_C = 10 \text{ A}$				1.7	
	$I_B = 2 \text{ A}$	$I_C = 10 \text{ A}$	$T_C = 100^\circ\text{C}$			1.6	
f_t Current gain bandwidth product	$V_{CE} = 10 \text{ V}$	$I_C = 0.5 \text{ A}$	$f = 1 \text{ MHz}$		8		MHz
C_{ob} Output capacitance	$V_{CB} = 20 \text{ V}$	$I_E = 0$	$f = 0.1 \text{ MHz}$		150		pF

NOTES: 2. Inductive loop switching measurement.

3. These parameters must be measured using pulse techniques, $t_p = 300 \mu\text{s}$, duty cycle $\leq 2\%$.

4. These parameters must be measured using voltage-sensing contacts, separate from the current carrying contacts.

thermal characteristics

PARAMETER	MIN	TYP	MAX	UNIT
$R_{\theta JC}$ Junction to case thermal resistance			1	$^\circ\text{C}/\text{W}$

inductive-load-switching characteristics at 25°C case temperature (unless otherwise noted)

PARAMETER	TEST CONDITIONS †			MIN	TYP	MAX	UNIT
t_{sv} Voltage storage time	$I_C = 10 \text{ A}$ $V_{BE(off)} = -5 \text{ V}$	$I_{B(on)} = 2 \text{ A}$	(see Figures 1 and 2)			2	μs
t_{rv} Voltage rise time						300	ns
t_{fi} Current fall time						200	ns
t_{ti} Current tail time						50	ns
t_{xo} Cross over time						400	ns
t_{sv} Voltage storage time	$I_C = 10 \text{ A}$ $V_{BE(off)} = -5 \text{ V}$	$I_{B(on)} = 2 \text{ A}$ $T_C = 100^\circ\text{C}$	(see Figures 1 and 2)			3.5	μs
t_{rv} Voltage rise time						400	ns
t_{fi} Current fall time						300	ns
t_{ti} Current tail time						80	ns
t_{xo} Cross over time						500	ns

† Voltage and current values shown are nominal; exact values vary slightly with transistor parameters.

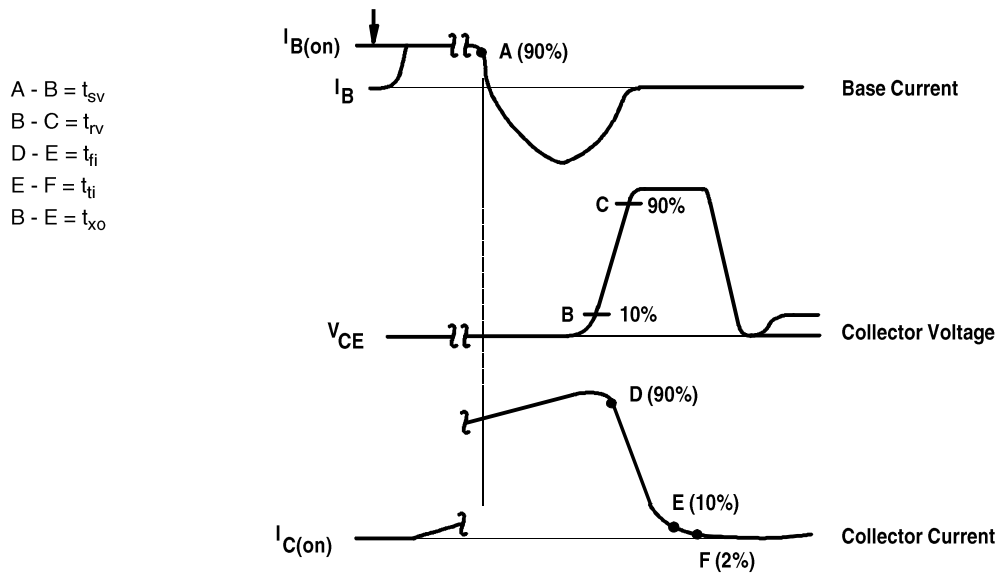

NOTES: A. Waveforms are monitored on an oscilloscope with the following characteristics: $t_r < 15$ ns, $R_{in} > 10 \Omega$, $C_{in} < 11.5$ pF.
 B. Resistors must be noninductive types.

Figure 2. Inductive-Load Switching Waveform s

TYPICAL CHARACTERISTICS

TYPICAL DC CURRENT GAIN
 VS
 COLLECTOR CURRENT

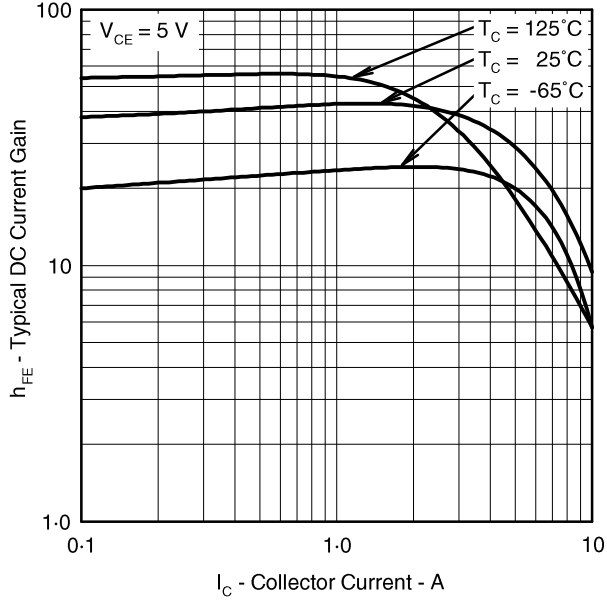

Figure 3.

COLLECTOR-EMITTER SATURATION VOLTAGE
 VS
 BASE CURRENT

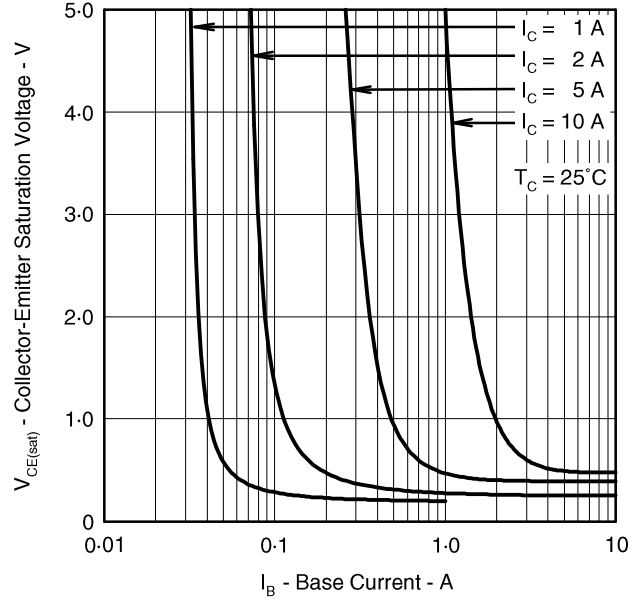

Figure 4.

COLLECTOR-EMITTER SATURATION VOLTAGE
 VS
 BASE CURRENT

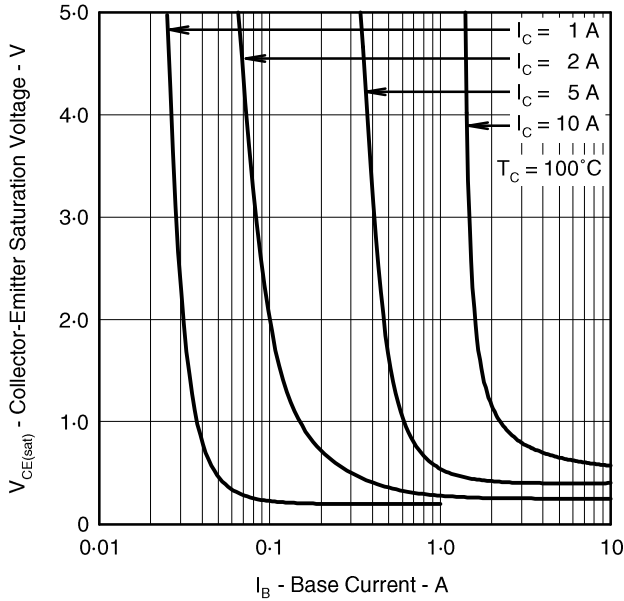

Figure 5.

BASE-EMITTER SATURATION VOLTAGE
 VS
 BASE CURRENT

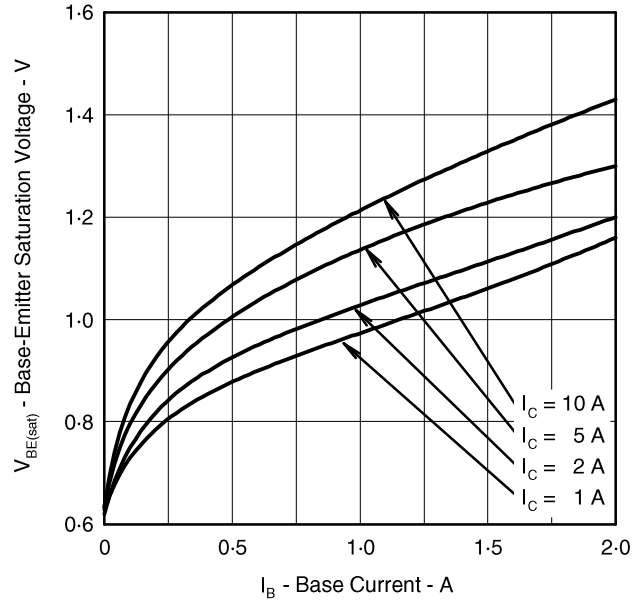

Figure 6.

TYPICAL CHARACTERISTICS

COLLECTOR CUT-OFF CURRENT
vs
CASE TEMPERATURE

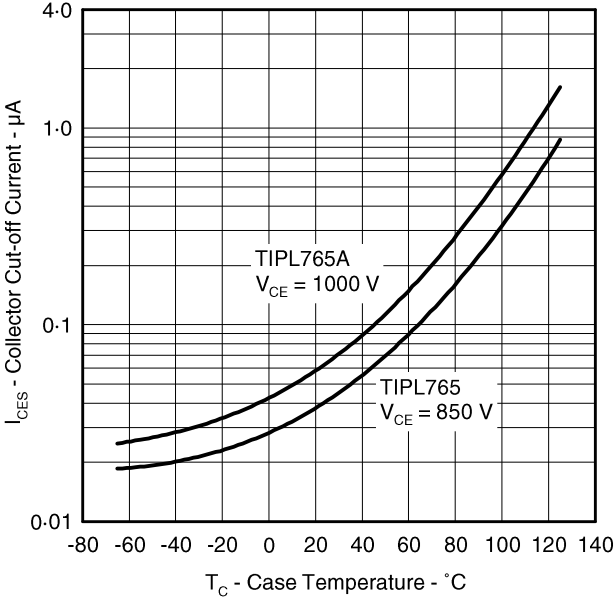

Figure 7.

MAXIMUM SAFE OPERATING REGIONS

MAXIMUM FORWARD-BIAS
SAFE OPERATING AREA

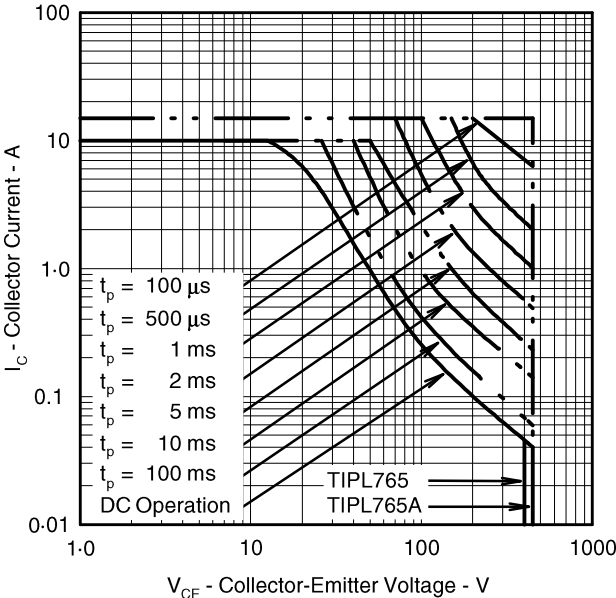

Figure 8.

TIPL765, TIPL765A NPN SILICON POWER TRANSISTORS

MECHANICAL DATA

SOT-93

3-pin plastic flange-mount package

This single-in-line package consists of a circuit mounted on a lead frame and encapsulated within a plastic compound. The compound will withstand soldering temperature with no deformation, and circuit performance characteristics will remain stable when operated in high humidity conditions. Leads require no additional cleaning or processing when used in soldered assembly.

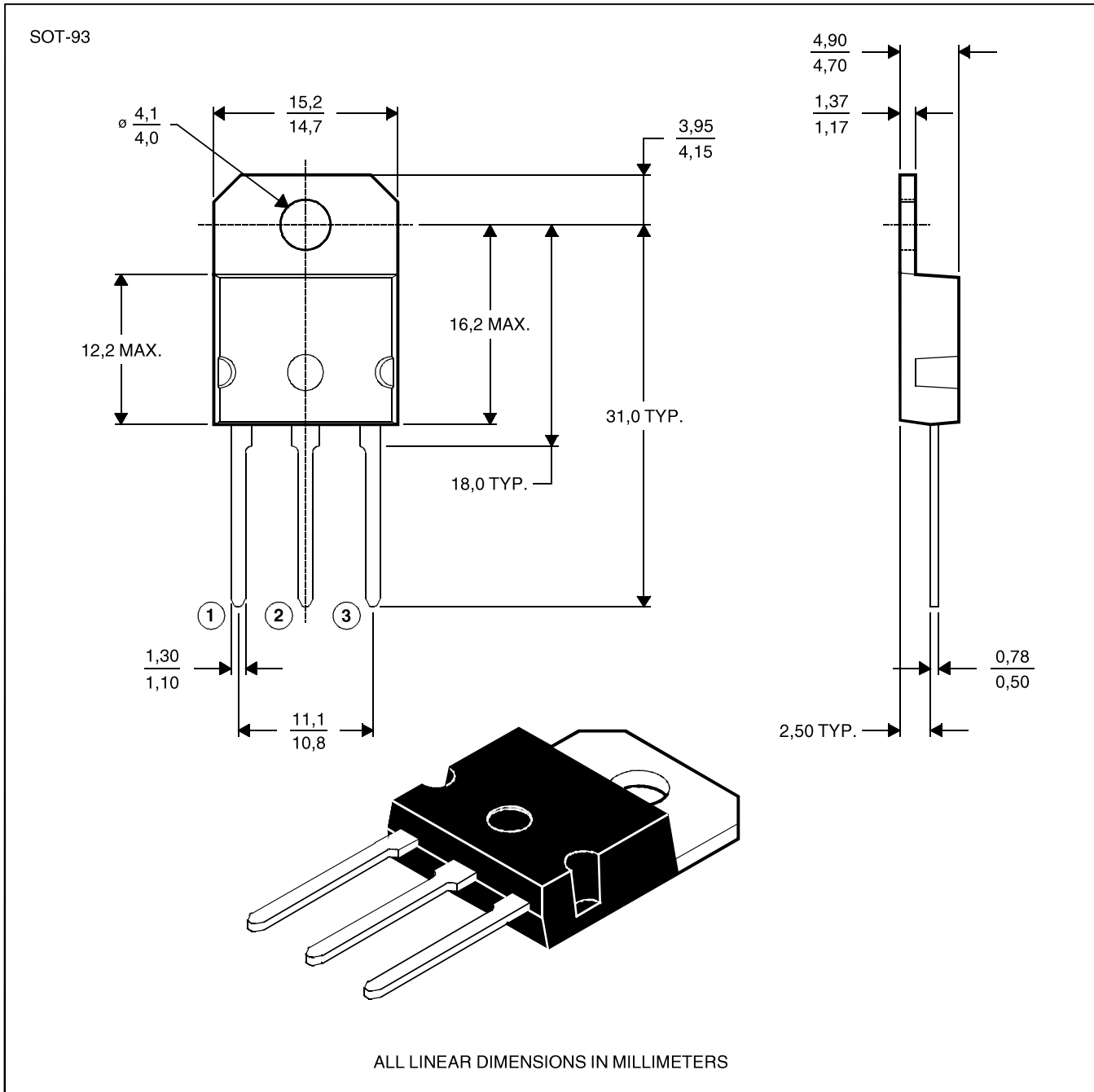

NOTE A: The centre pin is in electrical contact with the mounting tab.